



DREAMZZZ

71455



WARNING: CHOKING HAZARD. Toy contains small parts and a small ball. Not for children under 3 years.



Get excited about our new packaging!

We're switching from plastic to paper-based packaging. That's why you might find a mix of paper and plastic in our boxes!

Nos nouveaux emballages vous emballeront !

Nous passons des emballages en plastique aux emballages à base de papier. C'est pourquoi vous pourriez trouver un mélange de papier et de plastique dans nos boîtes !

¡Te presentamos nuestros nuevos empaques!

Estamos sustituyendo las bolsas de plástico por bolsas con base de papel. ¡Por eso, puedes encontrar una mezcla de papel y de plástico en nuestras cajas!

[LEGO.com/sustainable-packaging](https://www.lego.com/sustainable-packaging)



BUILDER



Apple and the Apple logo are trademarks of Apple Inc., registered in the U.S. and other countries and regions. App Store is a service mark of Apple Inc. Google Play and the Google Play logo are trademarks of Google LLC. Tencent and the Tencent logo are trademarks of Tencent Inc.

Q [LEGO.com/devicecheck](https://www.lego.com/devicecheck)

EN Ask parents' permission before going online | **DE** Eltern um Erlaubnis bitten, bevor du online gehst | **FR** Demande l'autorisation d'un parent avant d'aller en ligne | **IT** Chiedi il permesso ai tuoi genitori prima di andare online | **ES** Pídeles permiso a tus papás antes de conectarte a Internet | **PT** Pede autorização aos pais antes de acederes online | **ZH** 上网前应先征得父母的同意 | **PL** Poproś rodziców o zgodę, zanim wejdiesz do Internetu | **CS** Než půjdeš na internet, požádej rodiče o svolení | **SK** Skôr než pôjdeš na internet, vypýtaj si povolenie od rodičov | **HU** Kérj szülői engedélyt, mielőtt online csatlakoznál! | **RO** Cere permisiunea părinților înainte de a te conecta online | **BG** Поискайте разрешение от родител, преди да влезете онлайн | **LV** Pirms došanās tiešsaistē palūdz atļauju vecākiem | **ET** Enne Interneti kasutamist küsi vanematelt luba | **LT** Prieš prisijungdami prie interneto, atsiklauskite tėvų





AVERTISSEMENT : RISQUE D'ÉTOUFFEMENT.

Le jouet contient des petites pièces ainsi qu'une petite boule. Il ne convient pas aux enfants de moins de 3 ans.



ADVERTENCIA: PELIGRO DE ASFIXIA.

Juguete que contiene partes pequeñas y una pelota pequeña. No recomendado para niños menores de 3 años.

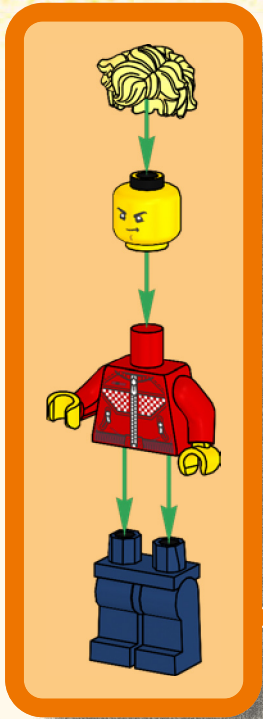
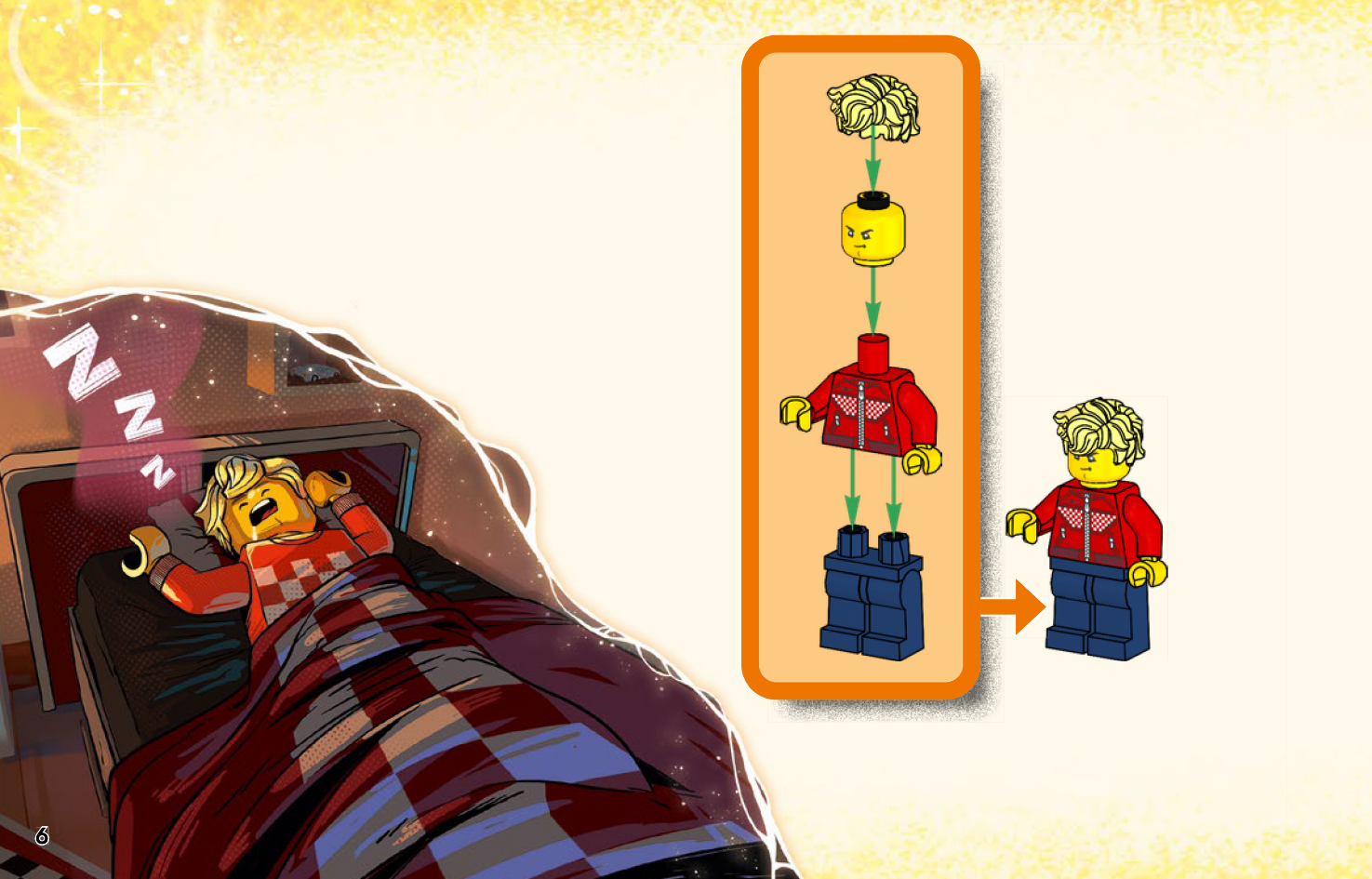



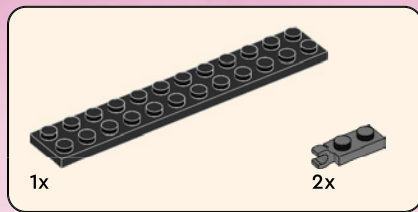

1

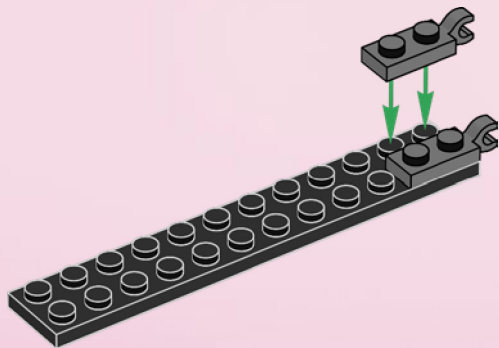

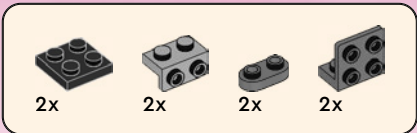

2

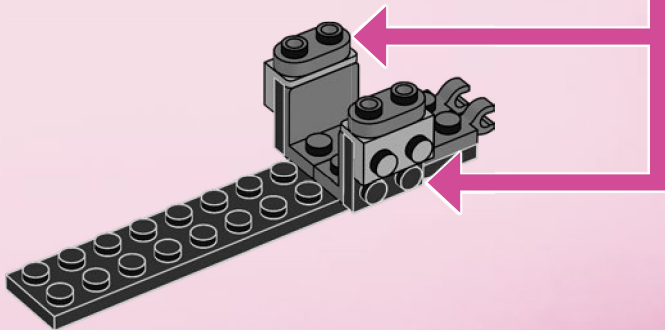
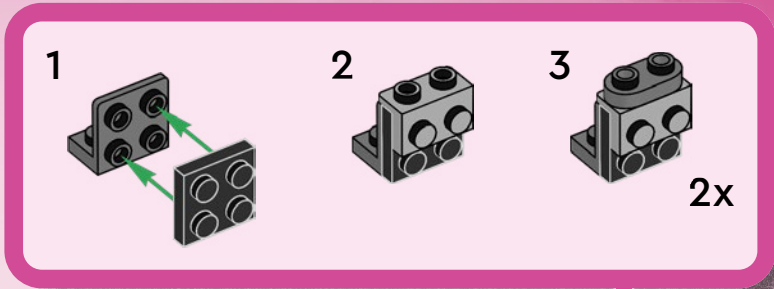



1x

3

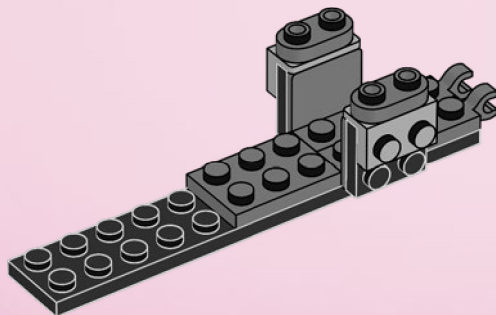



2x



2x

4

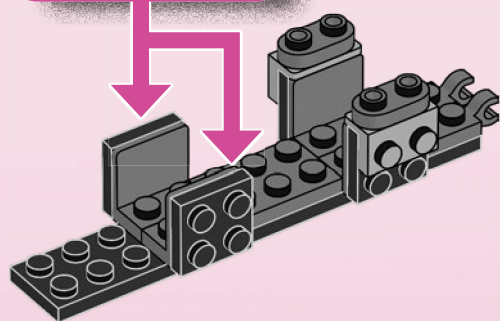
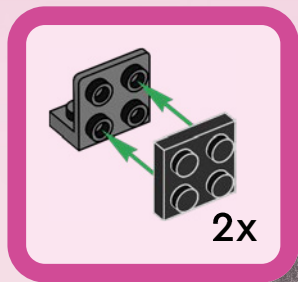

2x

5

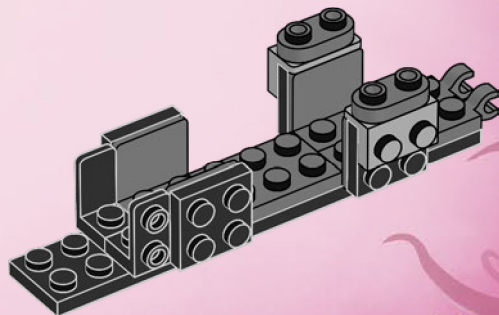



2x

6

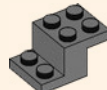
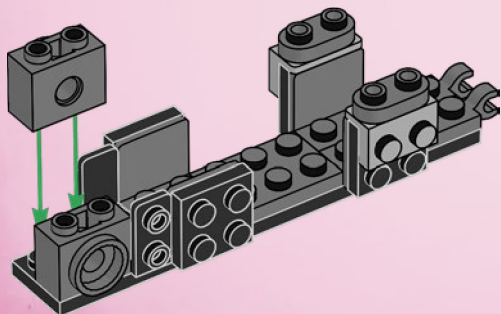

1x

7

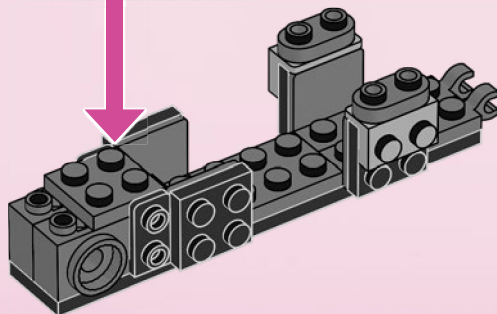
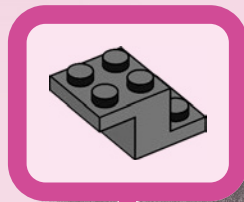

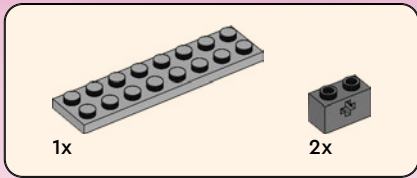

8

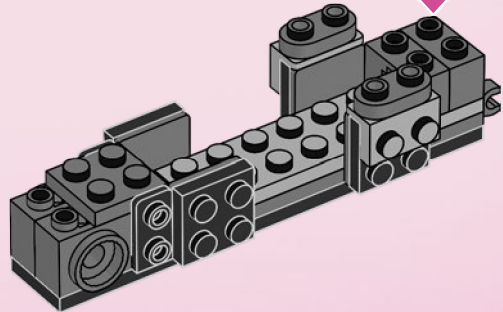
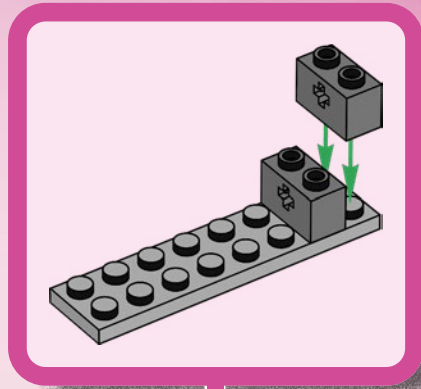



9

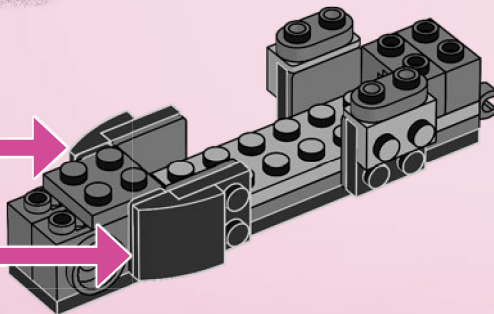



2x

10

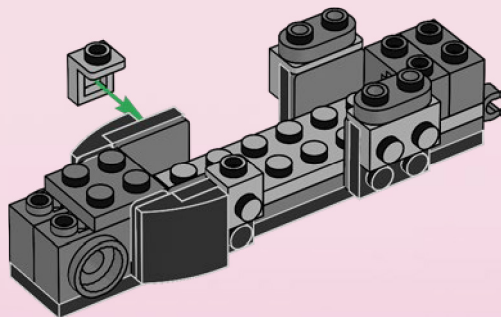

2x

11

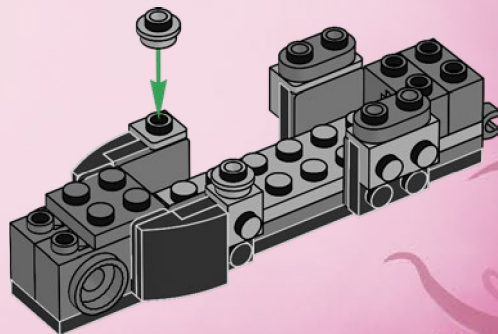

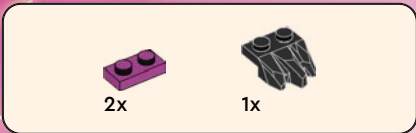

12

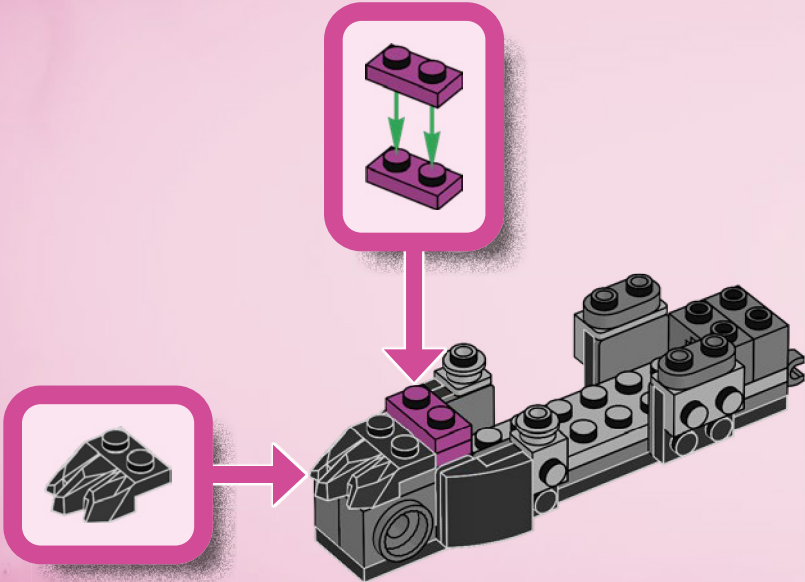



1x

13

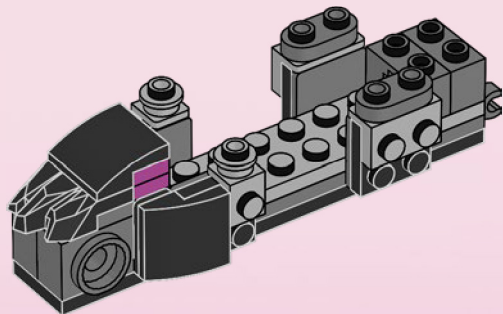

1x

14

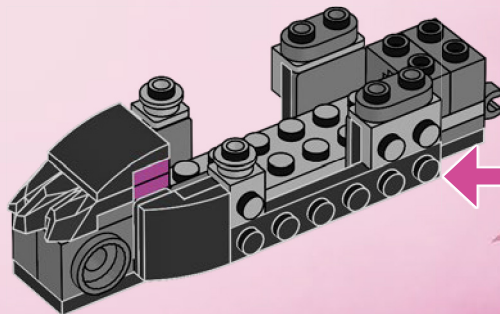
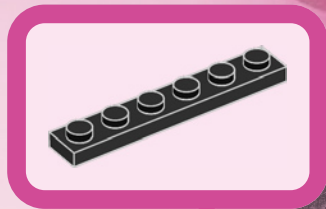

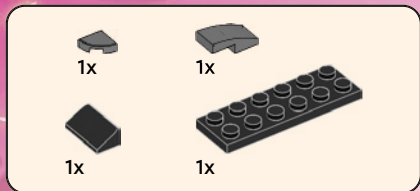

15

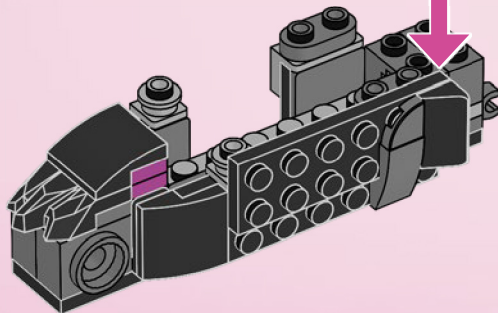
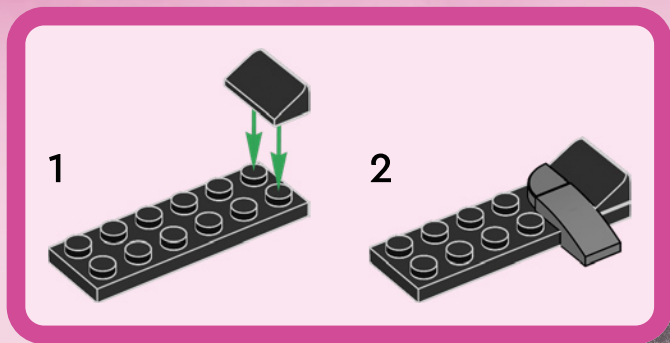



2x



2x

16

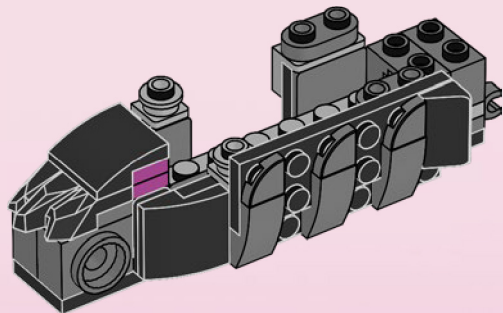

1x

17

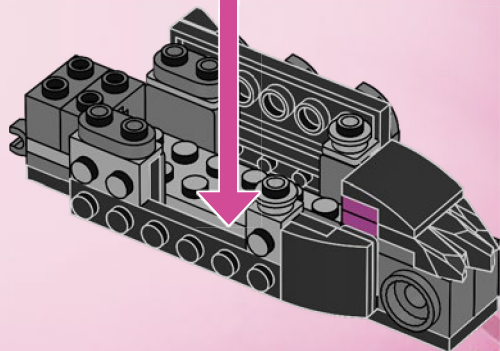
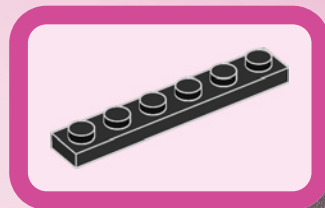
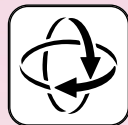

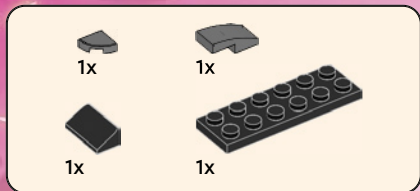

18

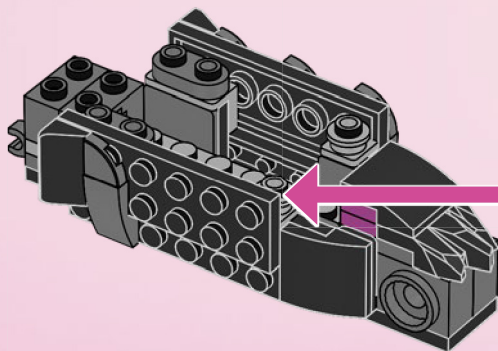
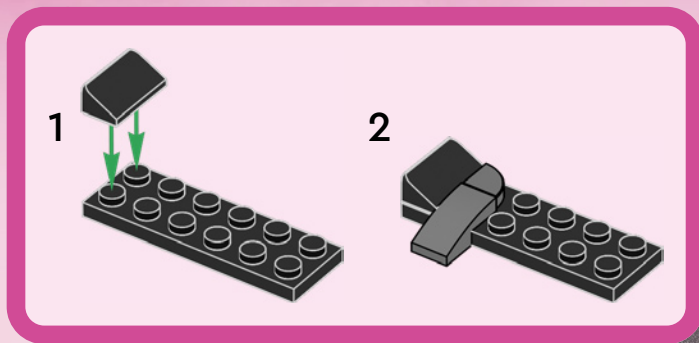



2x



2x

19

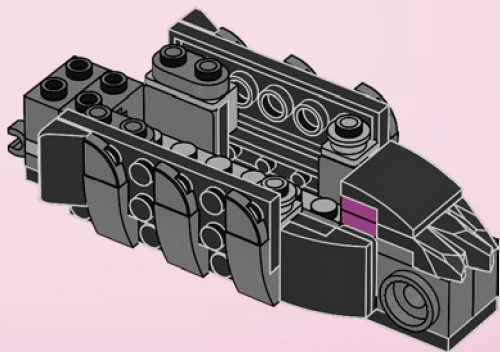

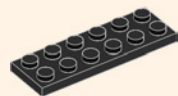
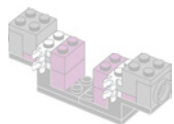

1x

20

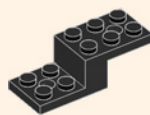
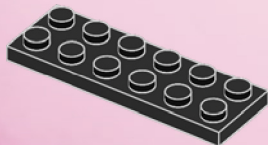

2x

21

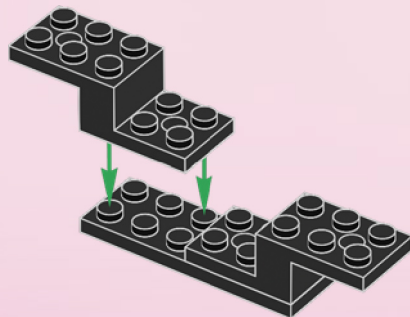



2x



2x

22

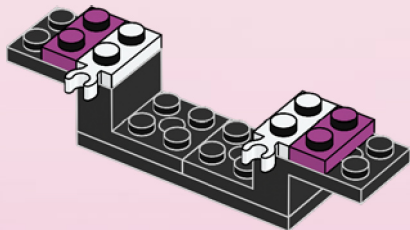

2x

23

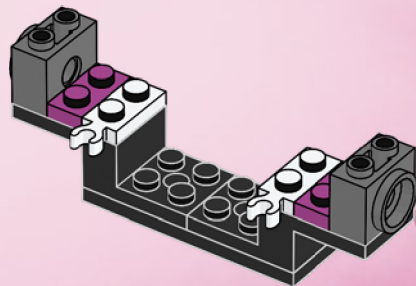



2x

24

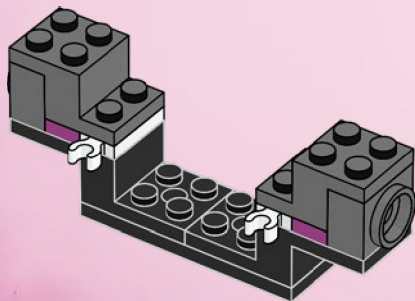

2x

25

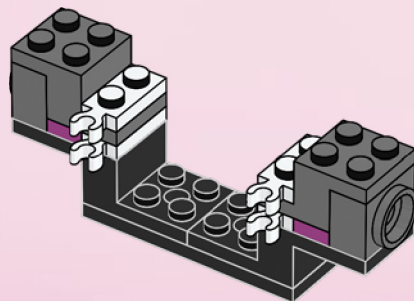



4x

26

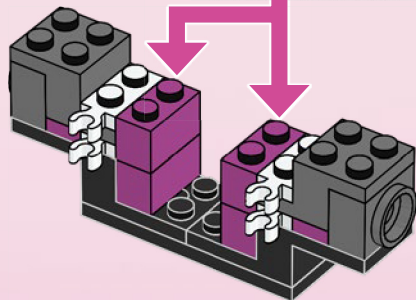
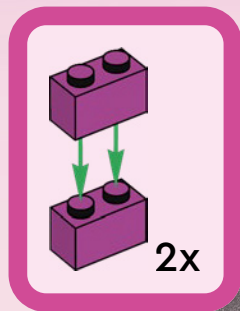

27

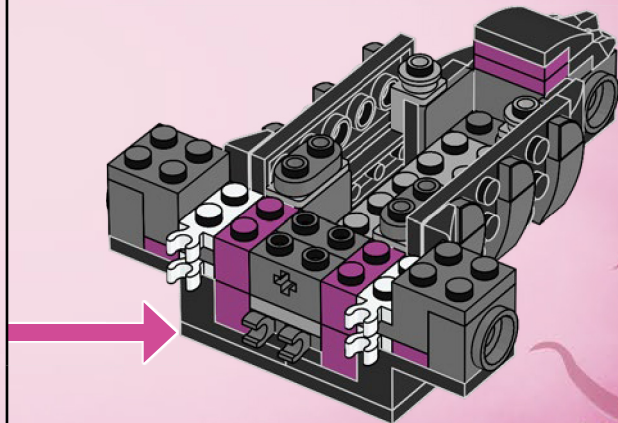

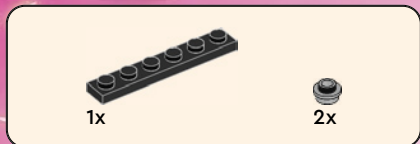

28

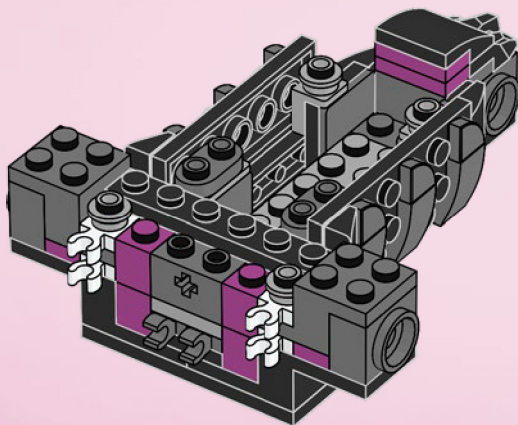



2x

29

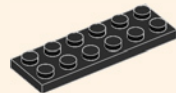
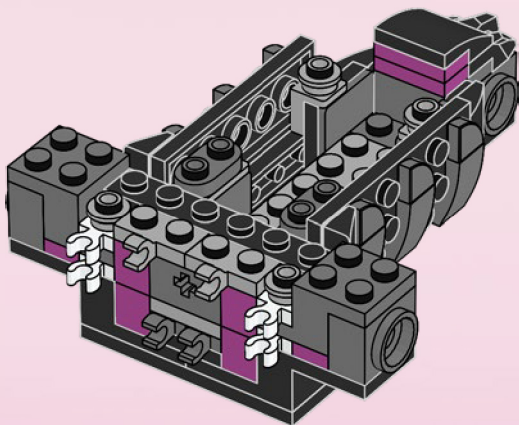

1x

30

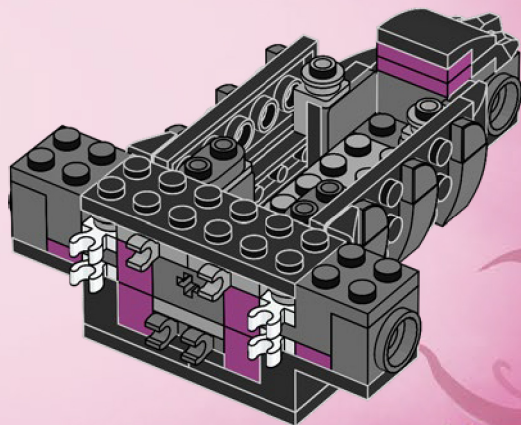



1x



2x



2x

31

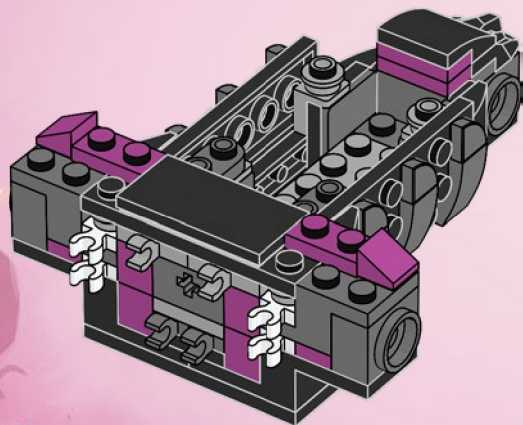

2x

32

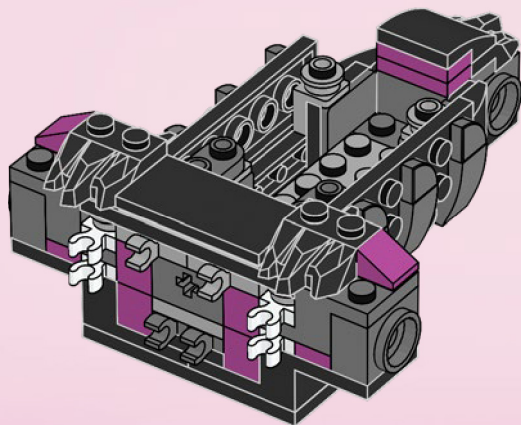

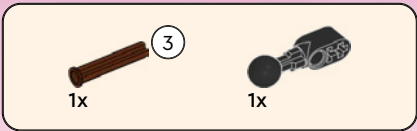

33

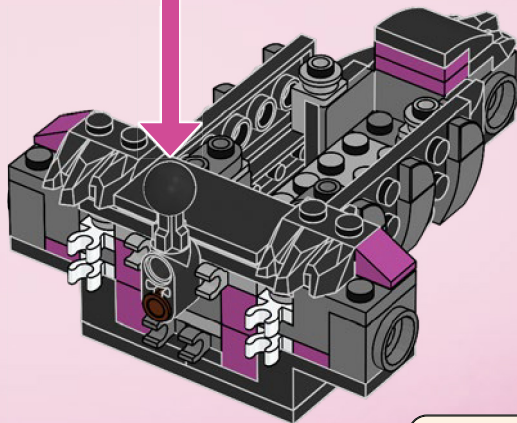
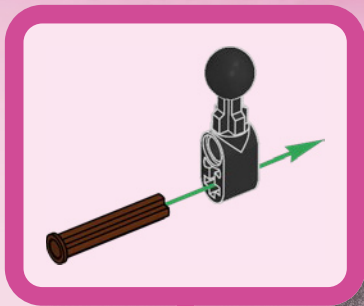



34

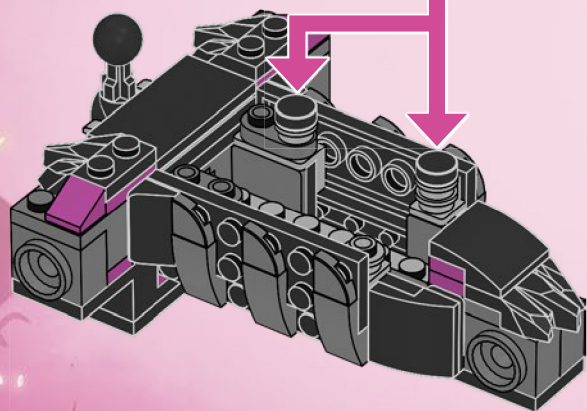
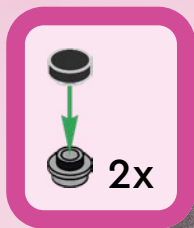

35

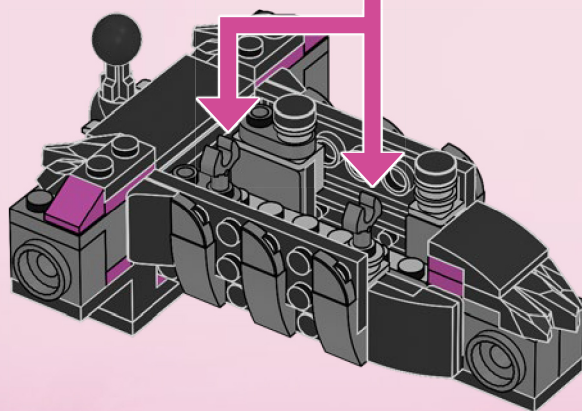

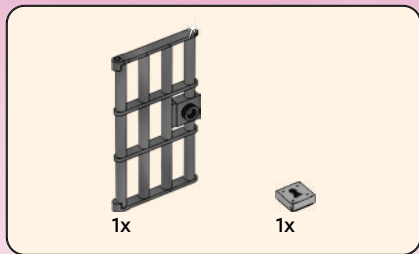

36

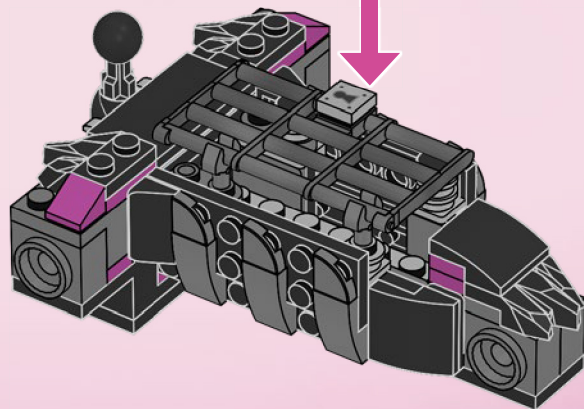
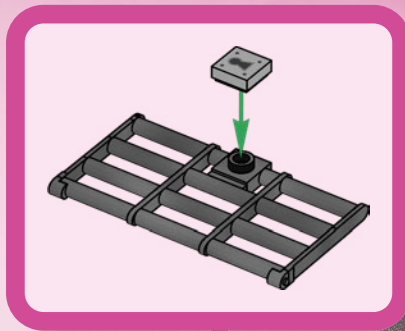

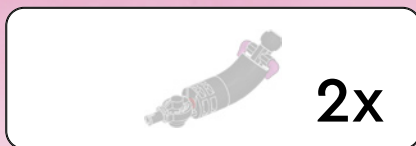

37

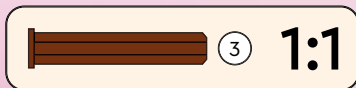
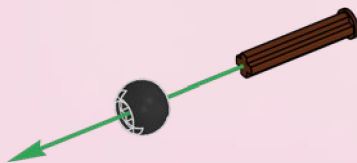



1x

38



2x

39

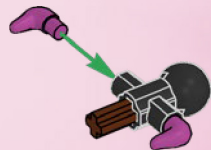



1x

40



1x

41

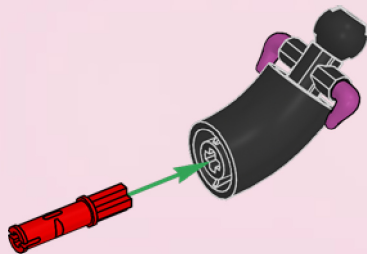



1x

42

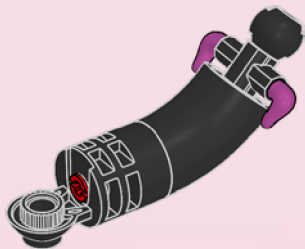

1x

43

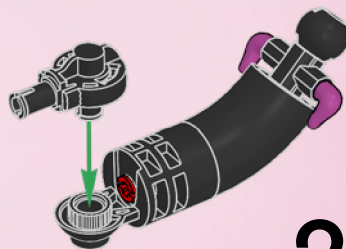

2x

44

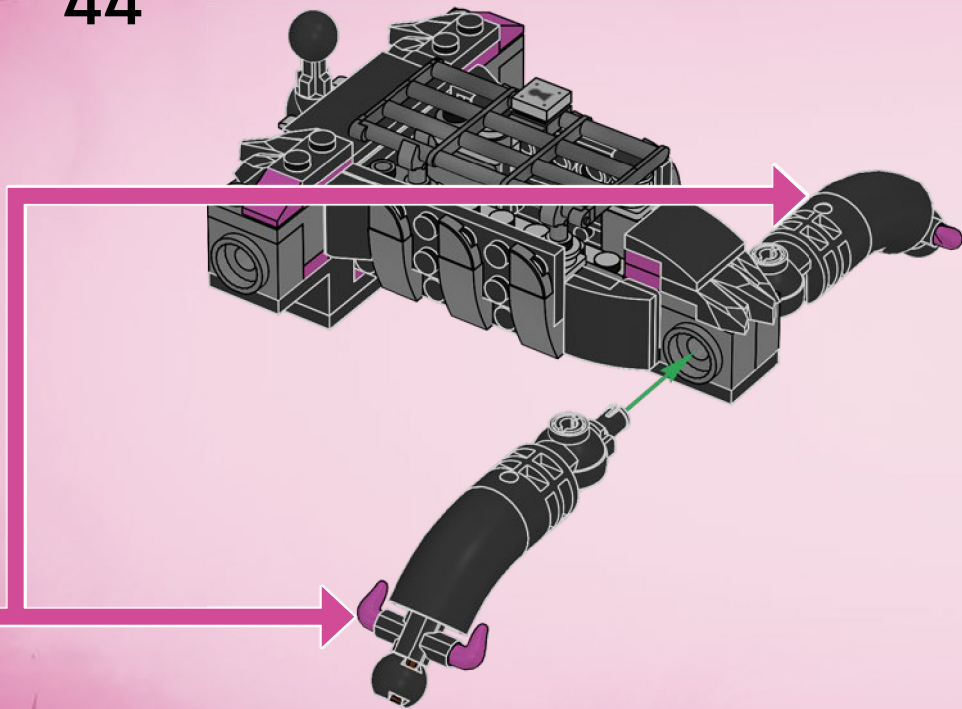

45

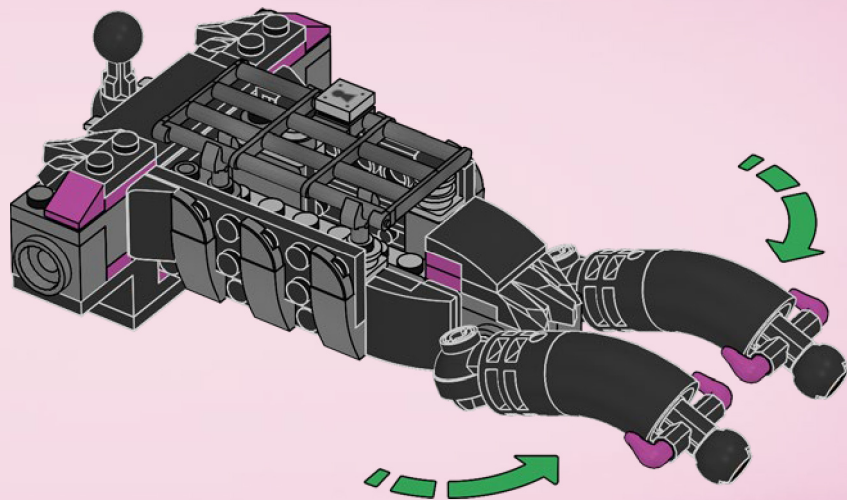

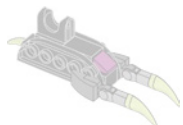

1x



1x

46

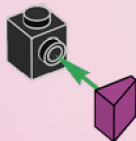

1x

47

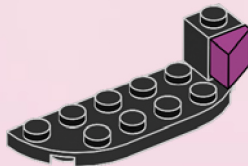



1x



1x

48

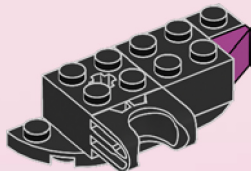

1x



1x

49

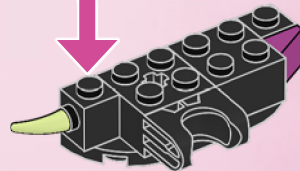
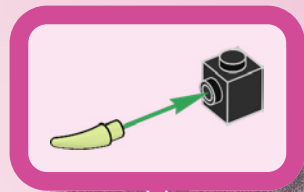



1x

50

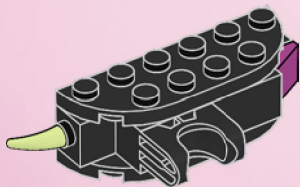

1x



1x

51

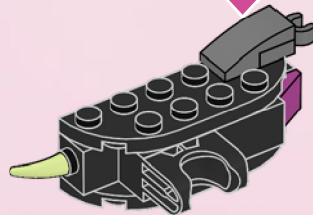
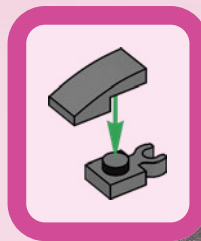



1x



1x

52

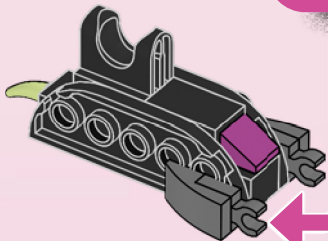
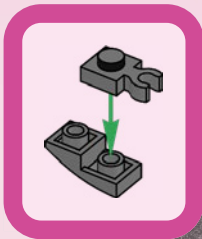

2x



2x

53

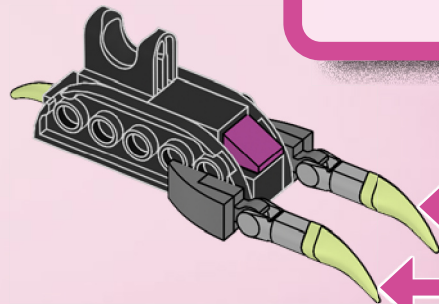
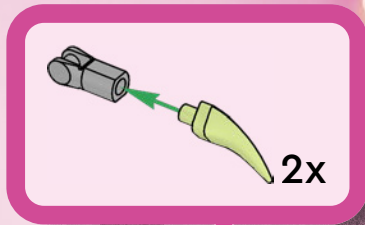

54

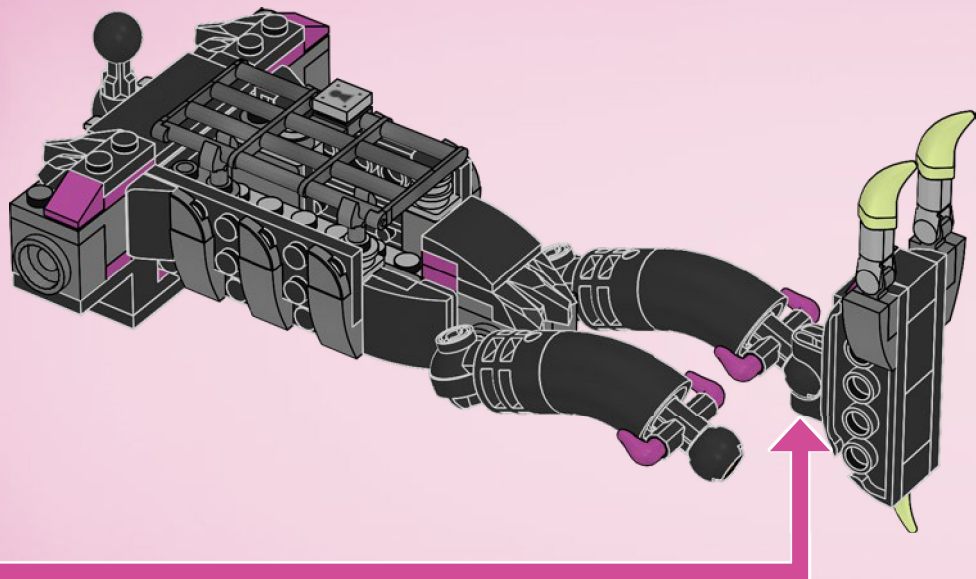

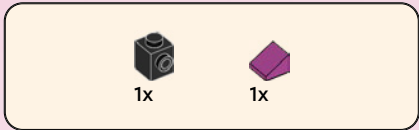
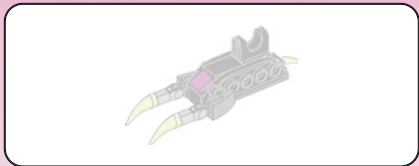

55

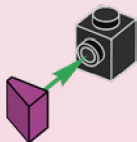

56

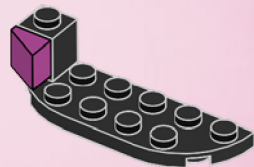



1x



1x

57

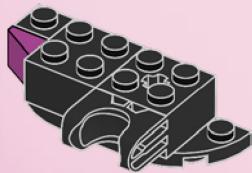

1x



1x

58

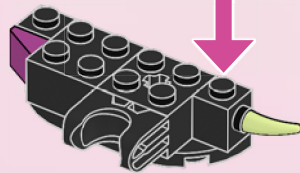
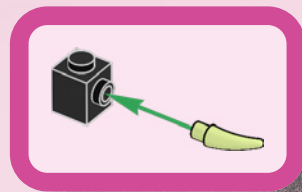



59

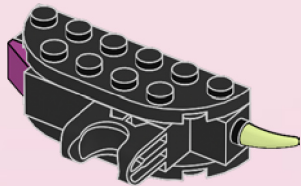

60

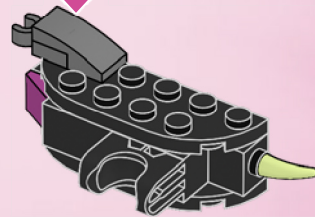
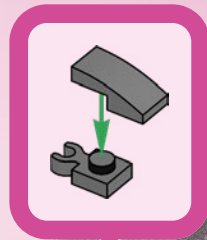



1x



1x

61

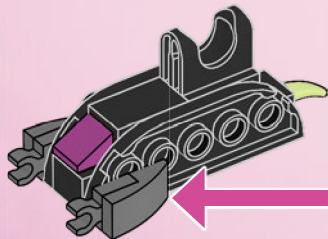
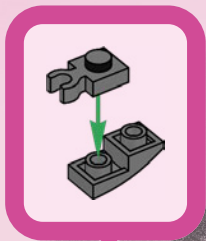

2x



2x

62

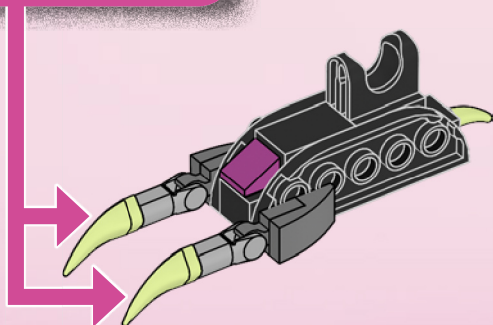
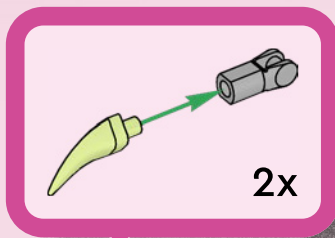

63

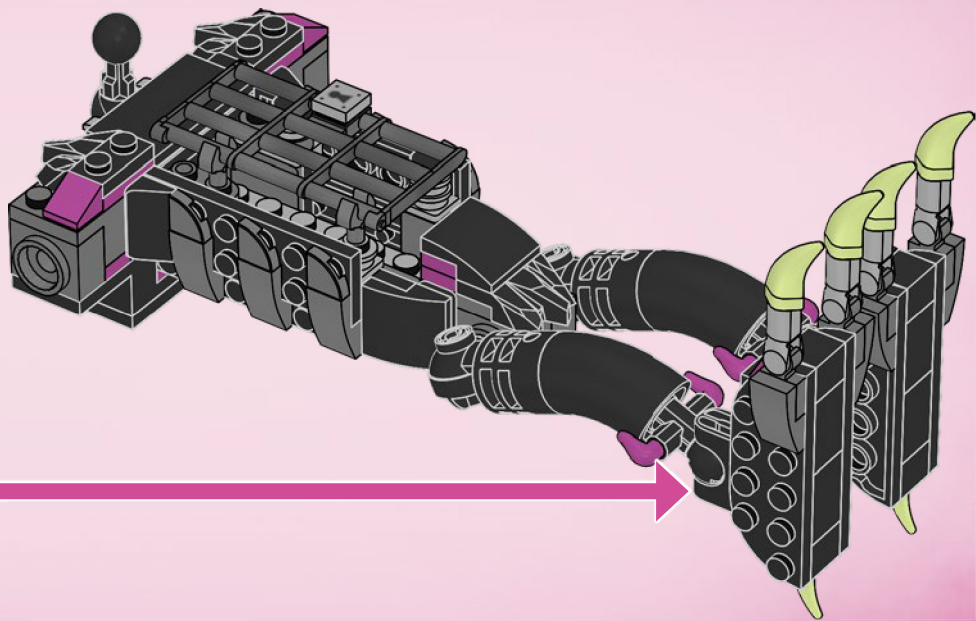



2x



2x



2x



2x



2x



2x

64

1

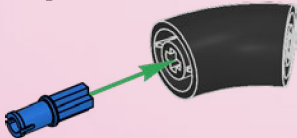

2

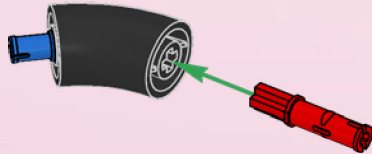

3

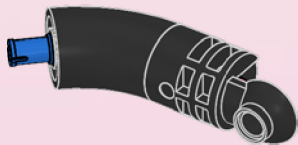

4

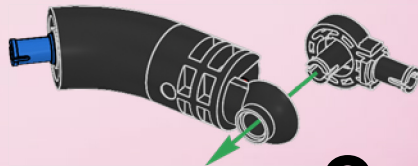

2x

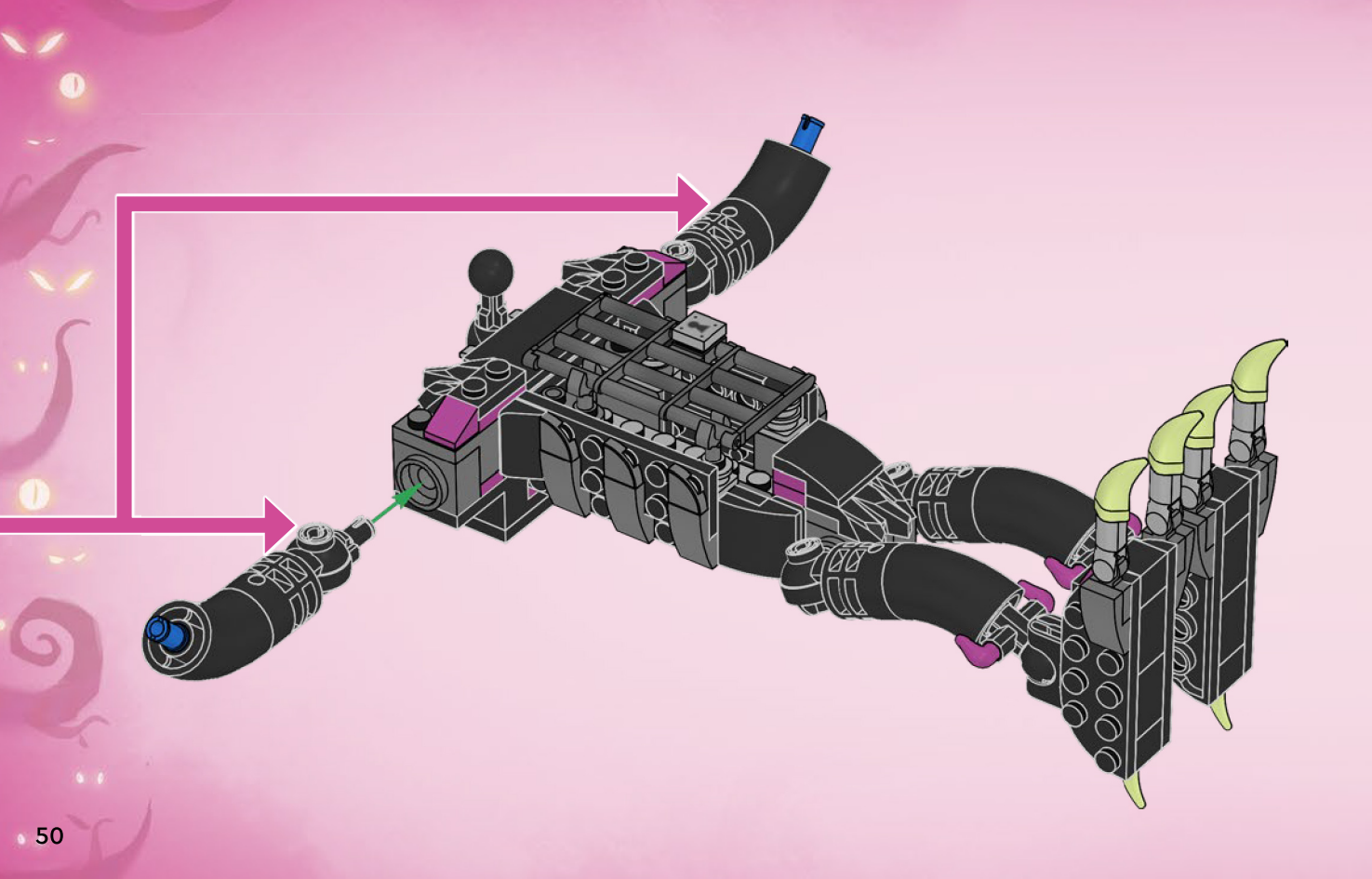

65

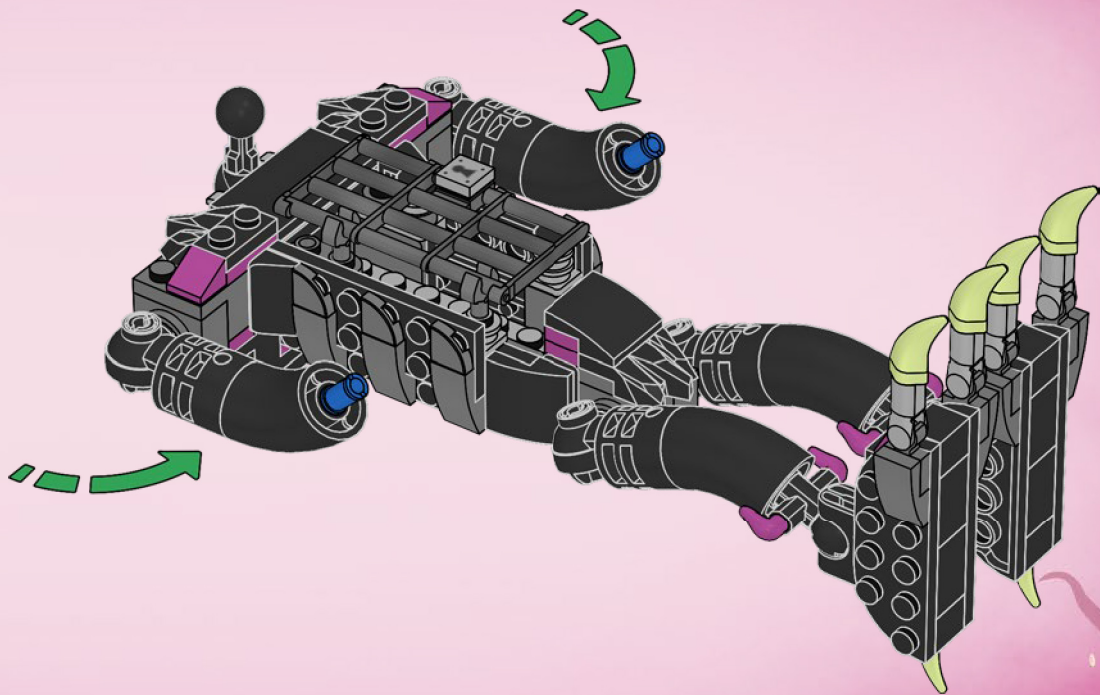



1x



1x

66

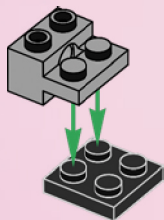

1x



1x

67

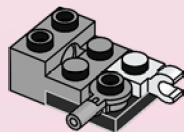



1x

68

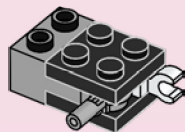

1x



1x

69

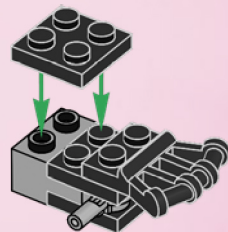



1x

70

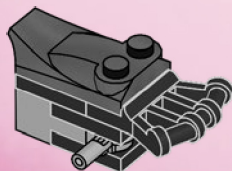

3x



3x

71

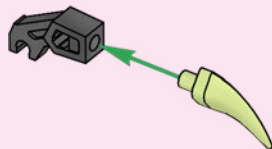

3x

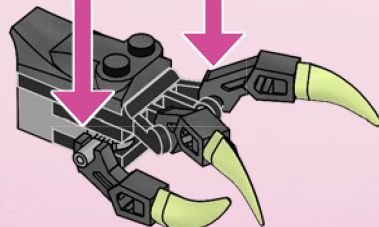

72

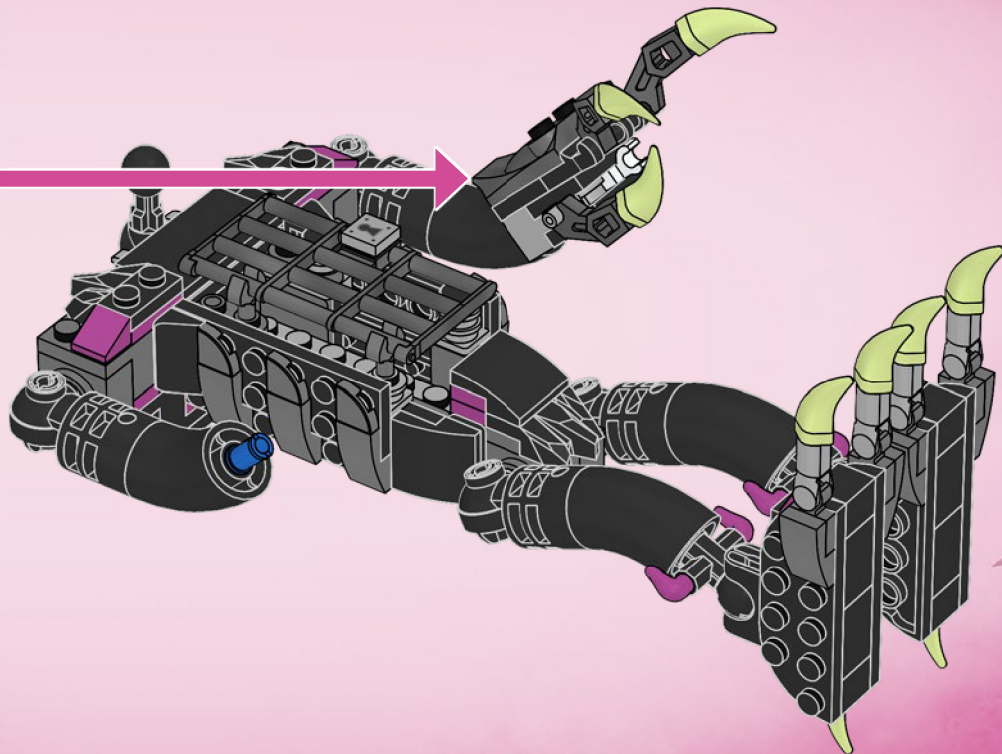



1x



1x

73

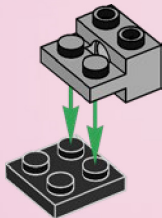

1x



1x

74

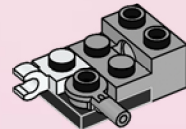



1x

75

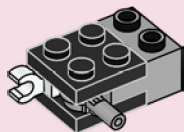

1x



1x

76

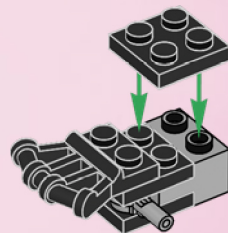



1x

77

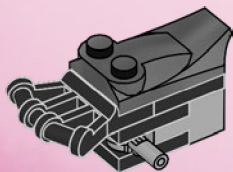

3x



3x

78

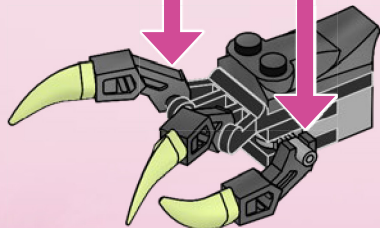
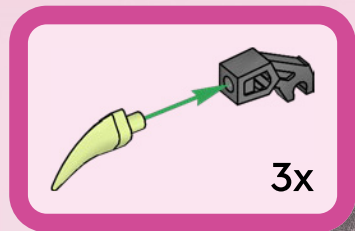

79

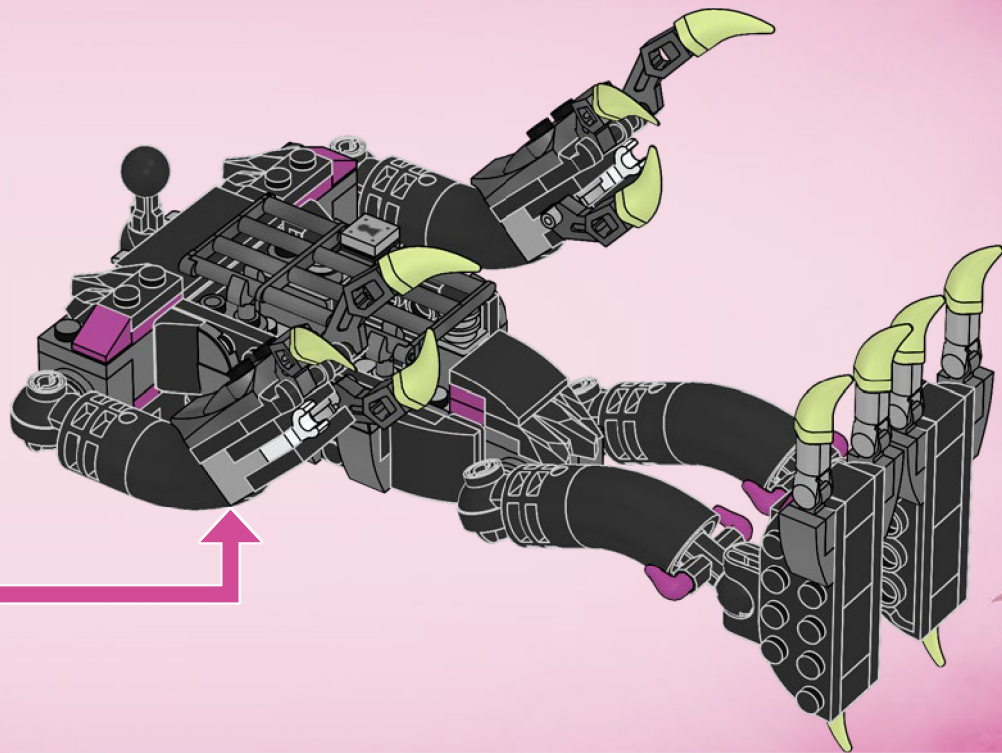



2x

80

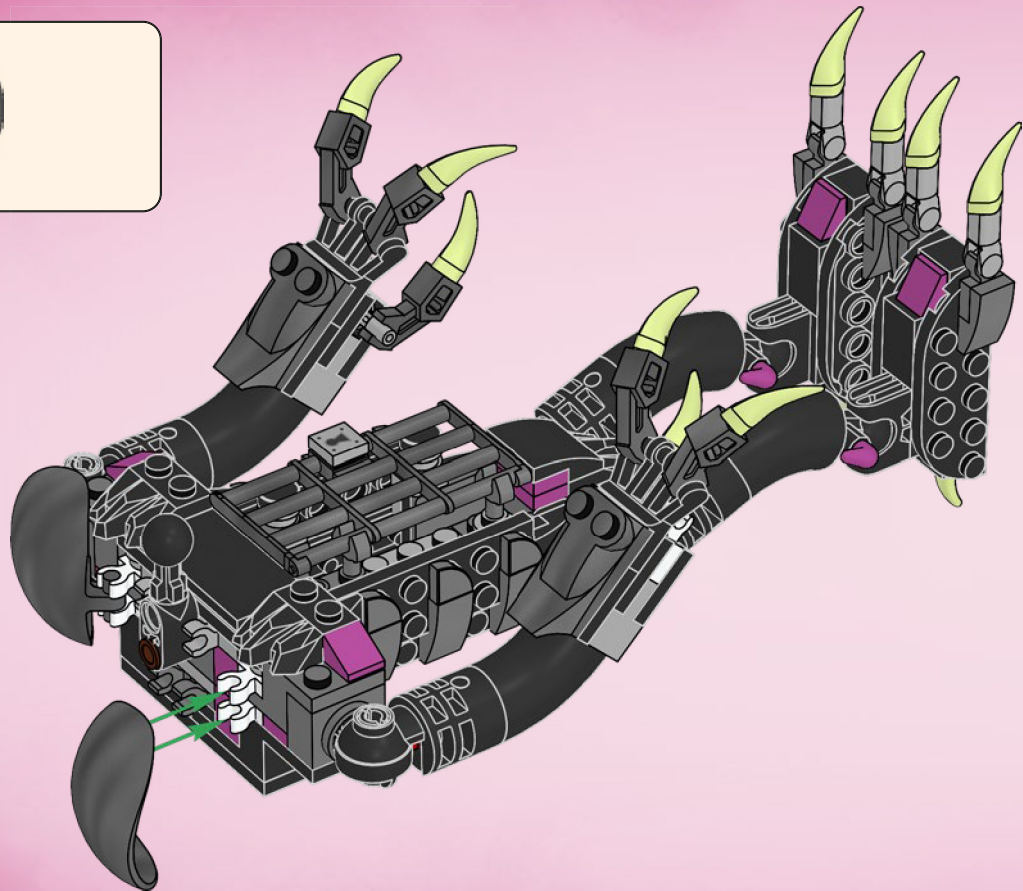

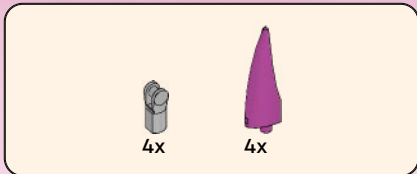

81

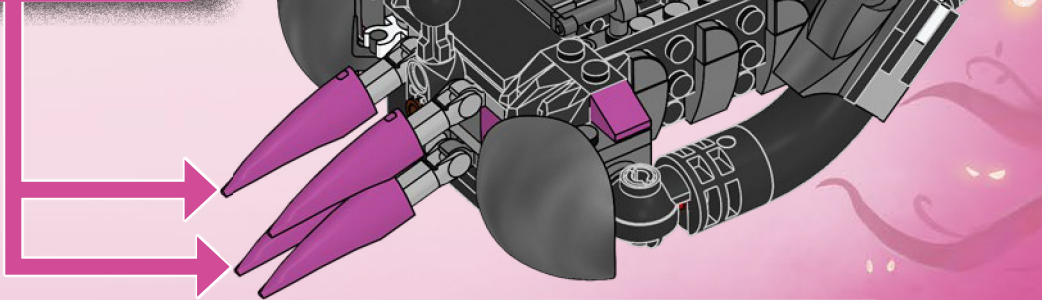
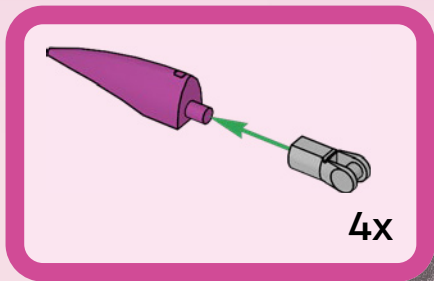



1x

82



1x

83

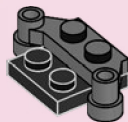

1x

84

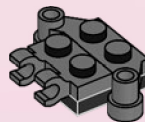



1x

85

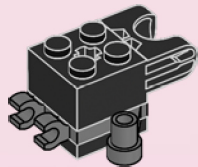

2x

86

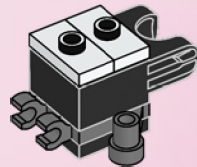



1x

87

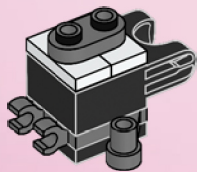

2x

88

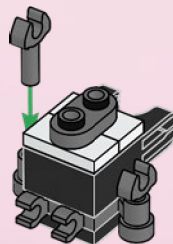

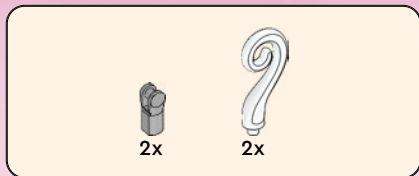

89

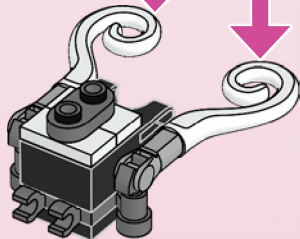
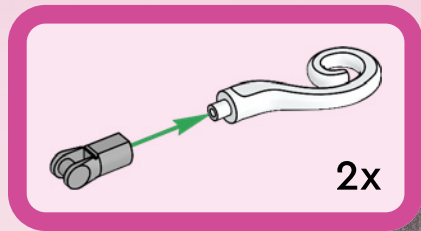

90

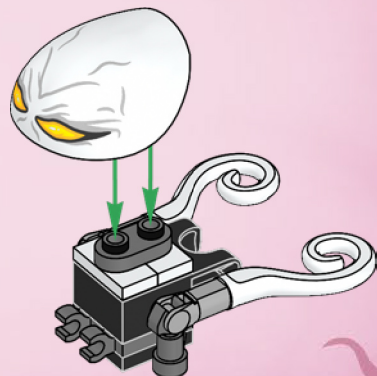

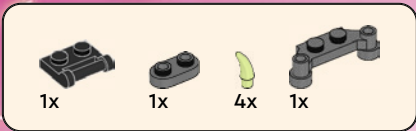

91

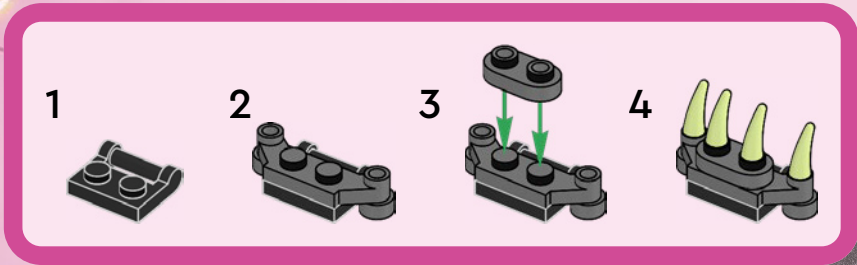

92

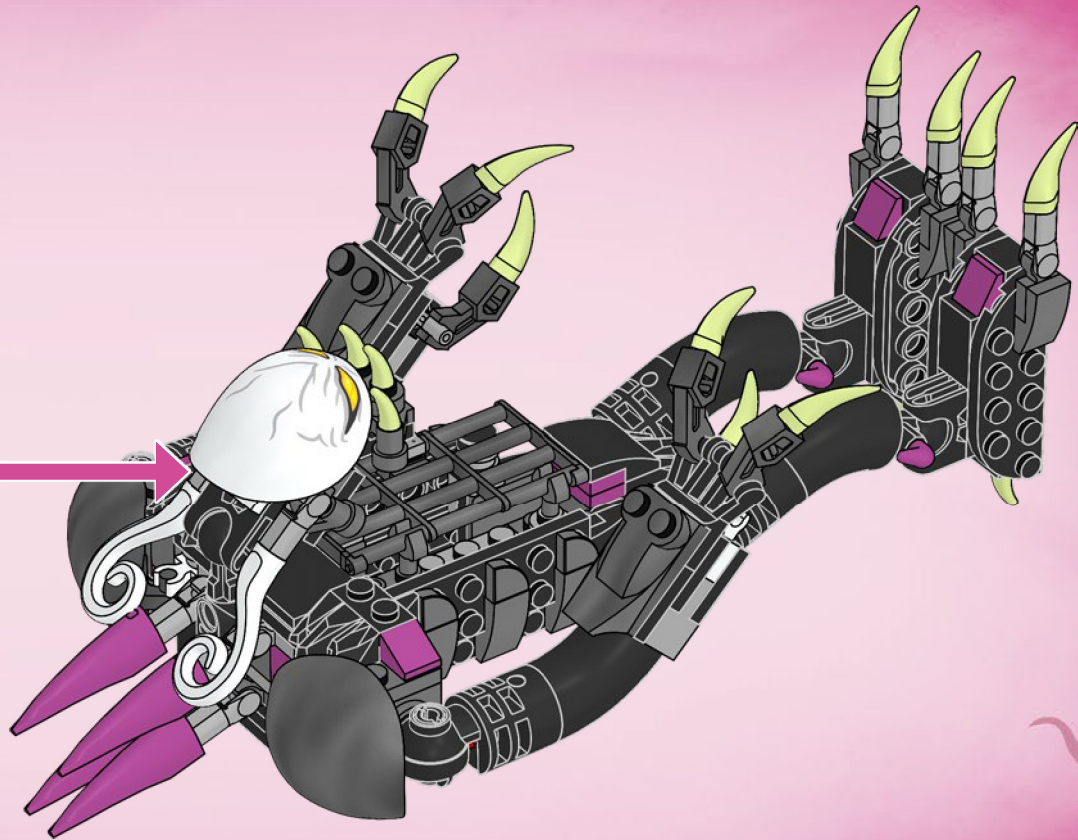



1x



1x

93

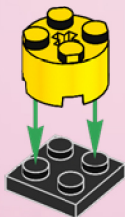

1x

94

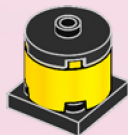



1x



3x



1x

95

1

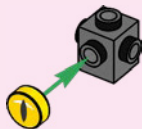

2

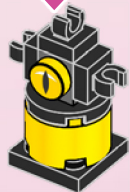
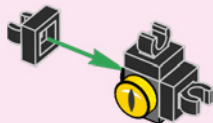



2x

96

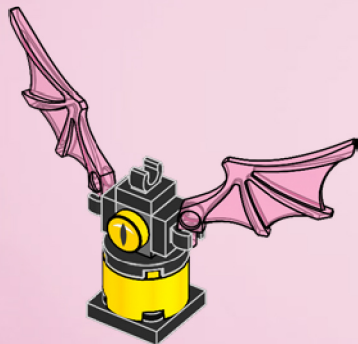

1x

97

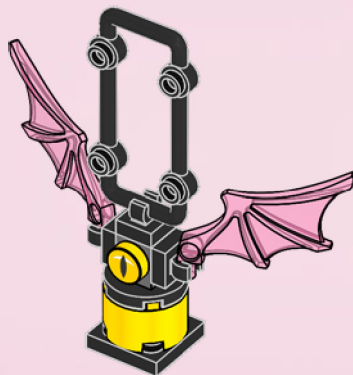

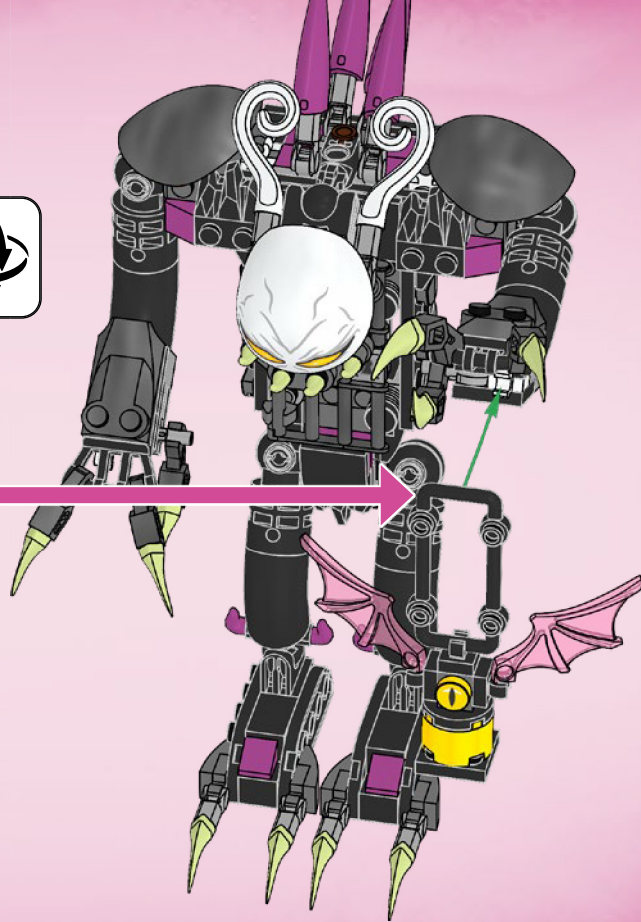

98

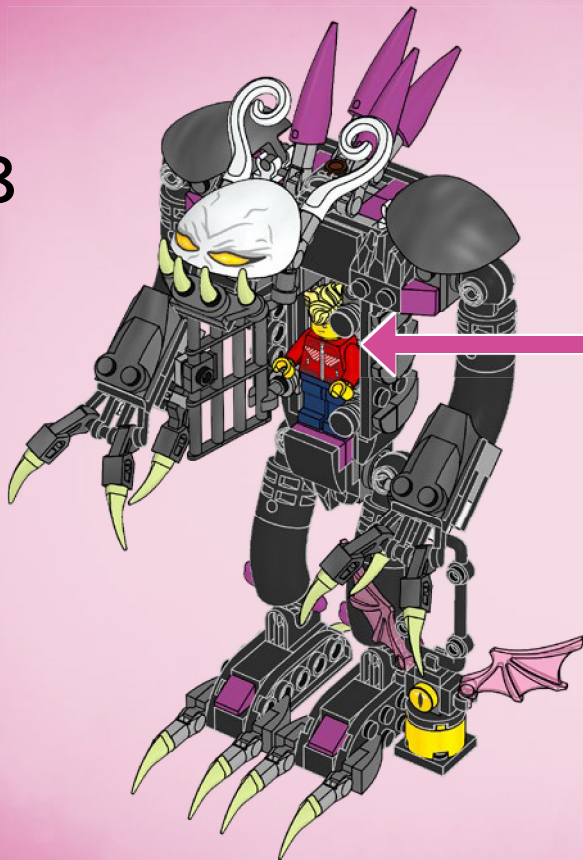



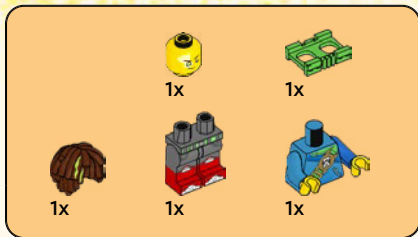

1

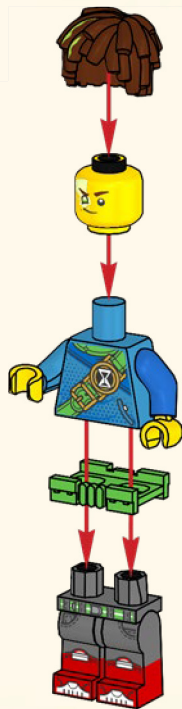



2

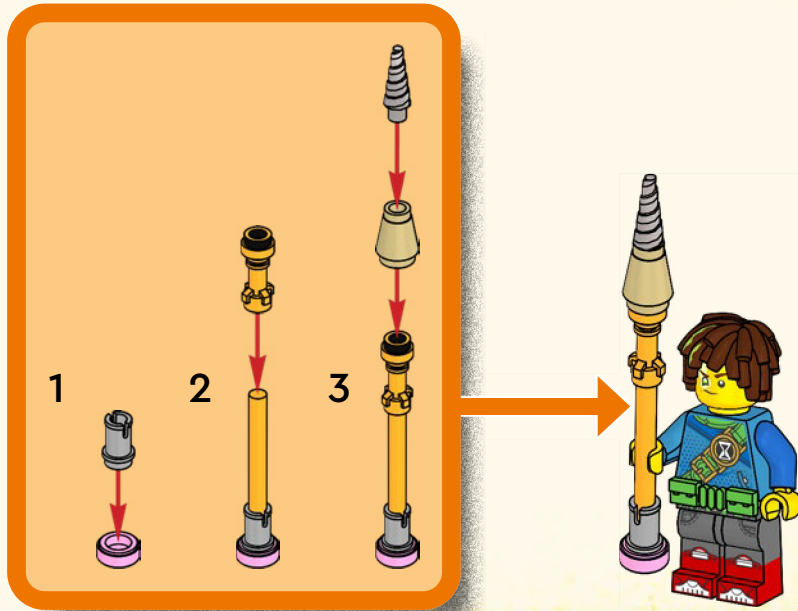



1x



1x

3

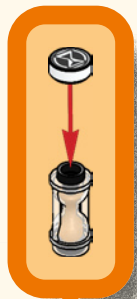



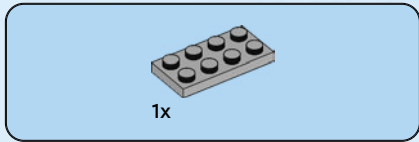

1

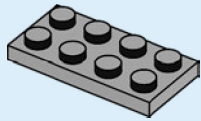

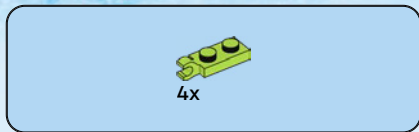

2

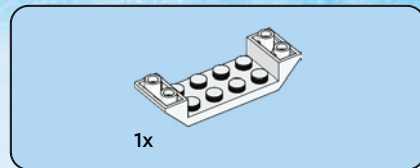
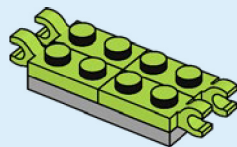

3

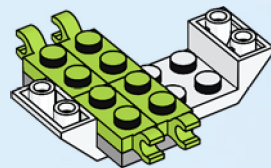

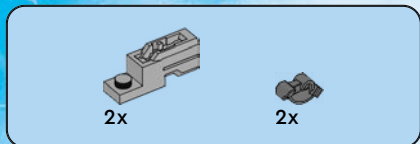

4

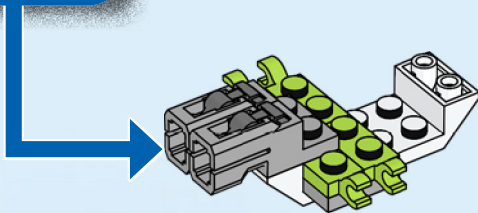
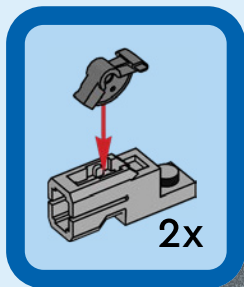

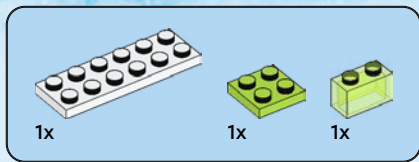

5

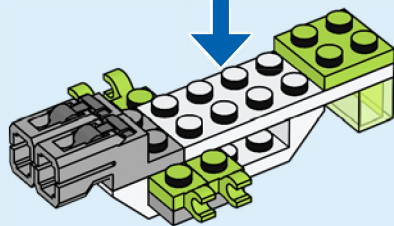
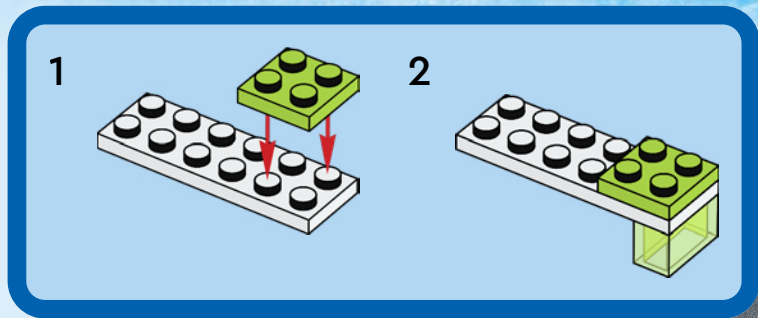



2x



4x



2x

6

1

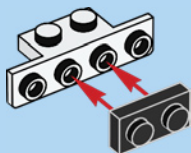

2



2x

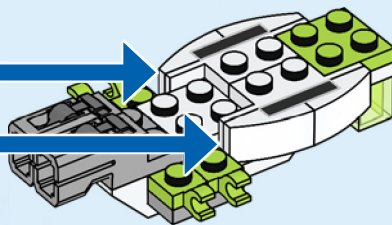



1x

7

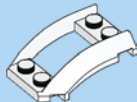
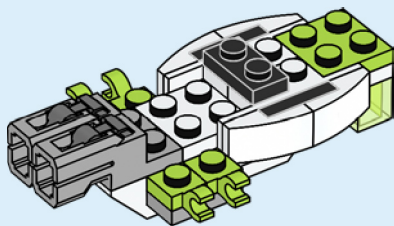

1x

8

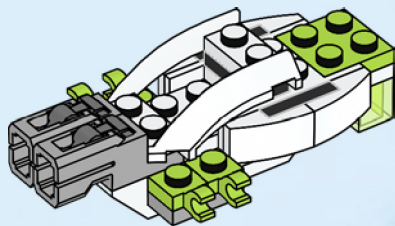



1x



2x

9

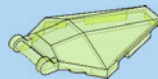
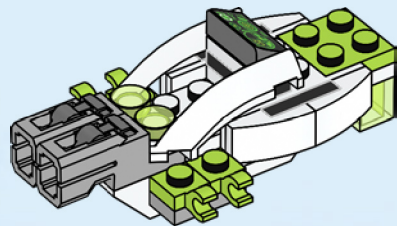

2x

10

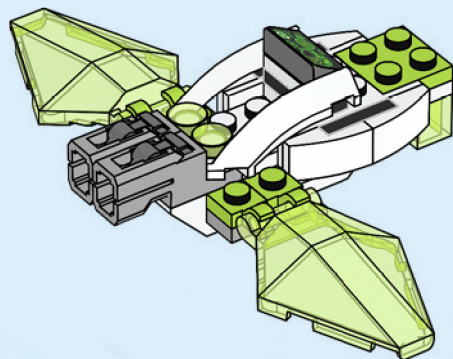



1x

11

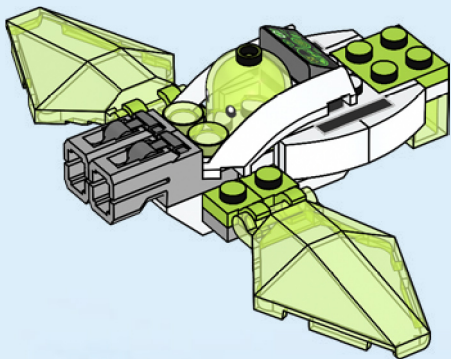

2x

12

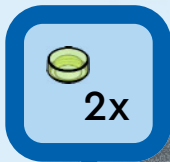

2x

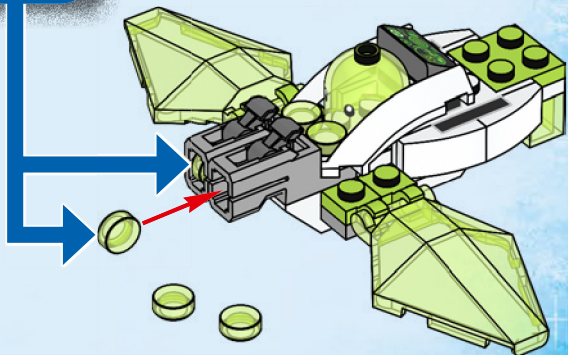

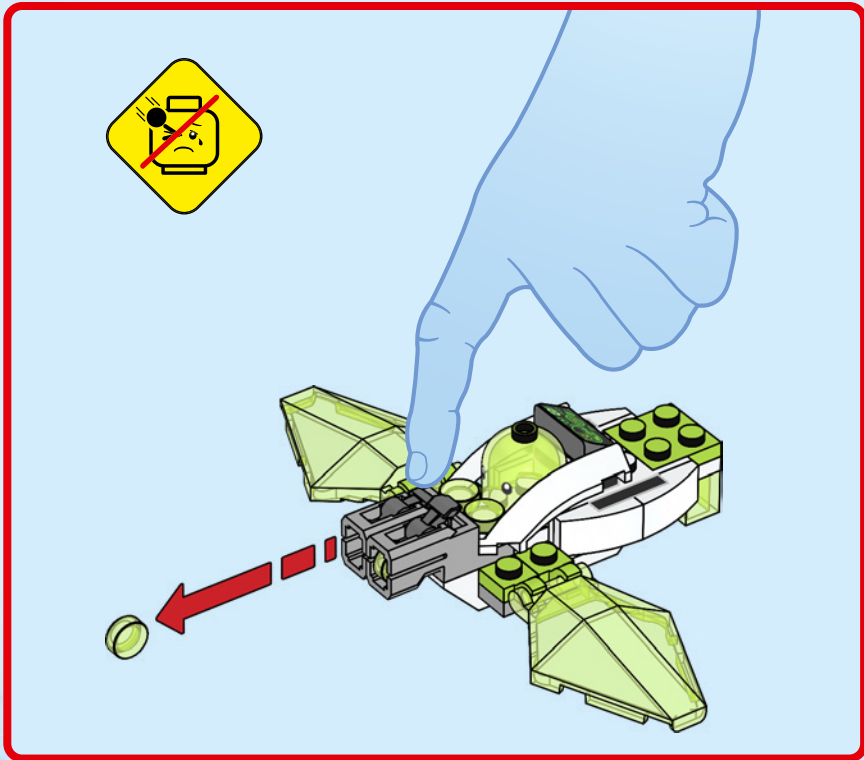



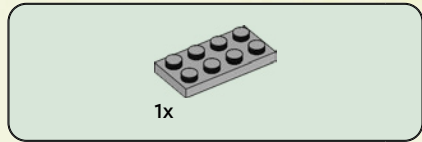

1

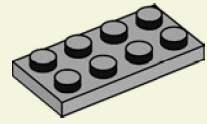



4x

2

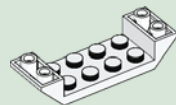
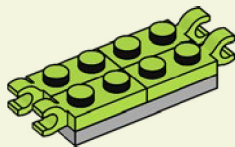

1x

3

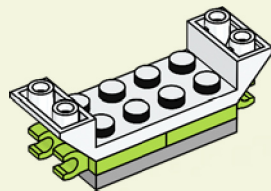



2x

4

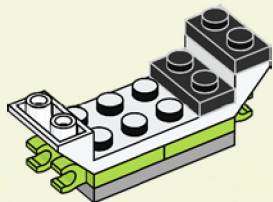

2x

5

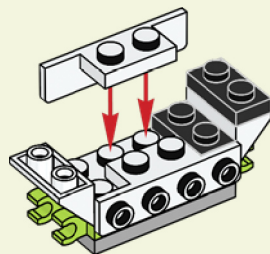



1x

6

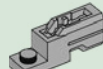
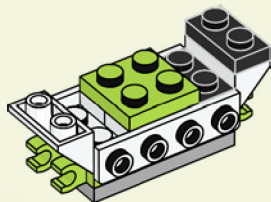

2x



2x

7

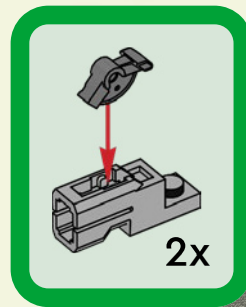

2x

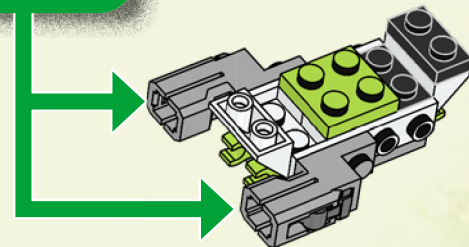



2x

8

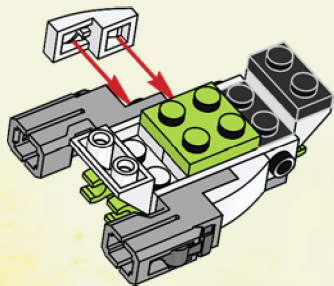

2x

9

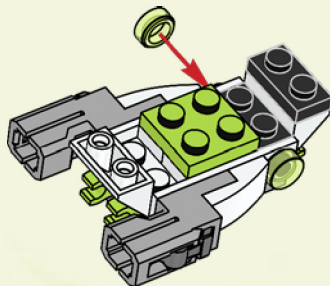

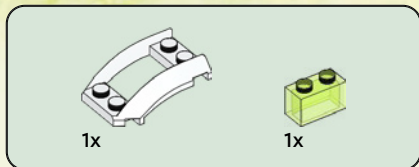

10

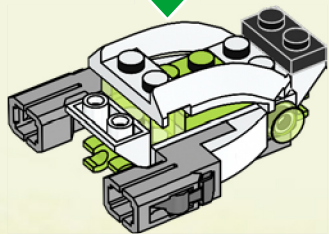
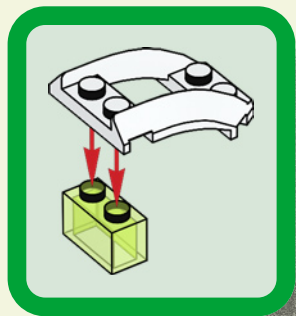

11

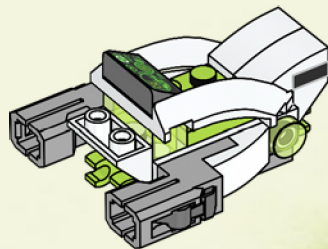



1x



1x

12

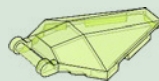
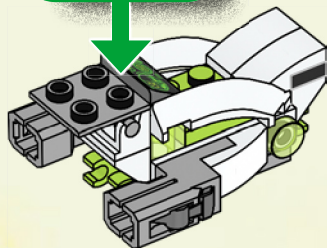
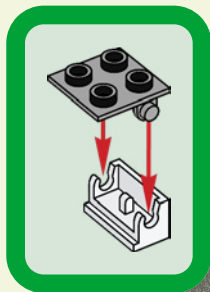

2x

13

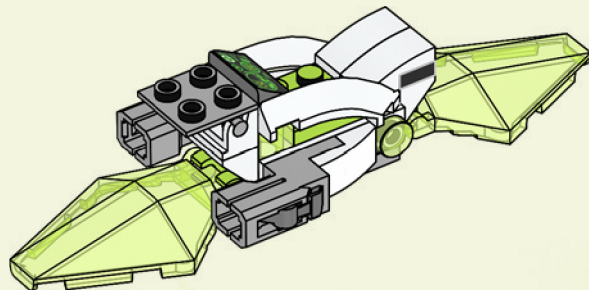



1x

14

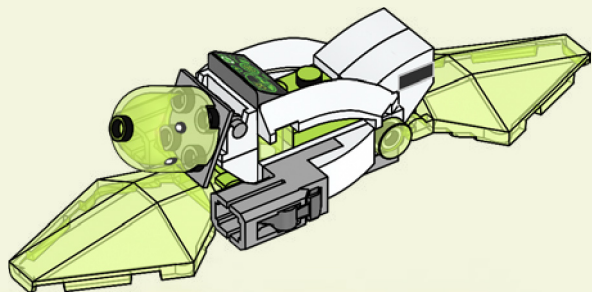

4x

15



2x

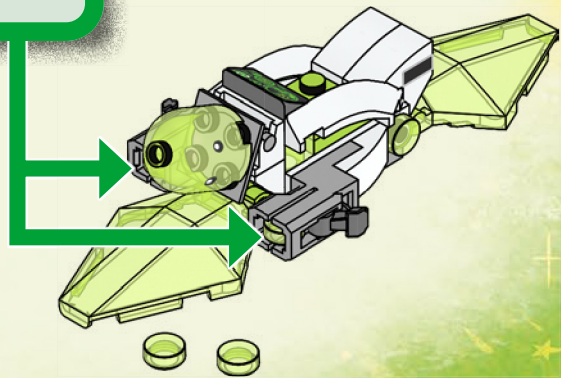

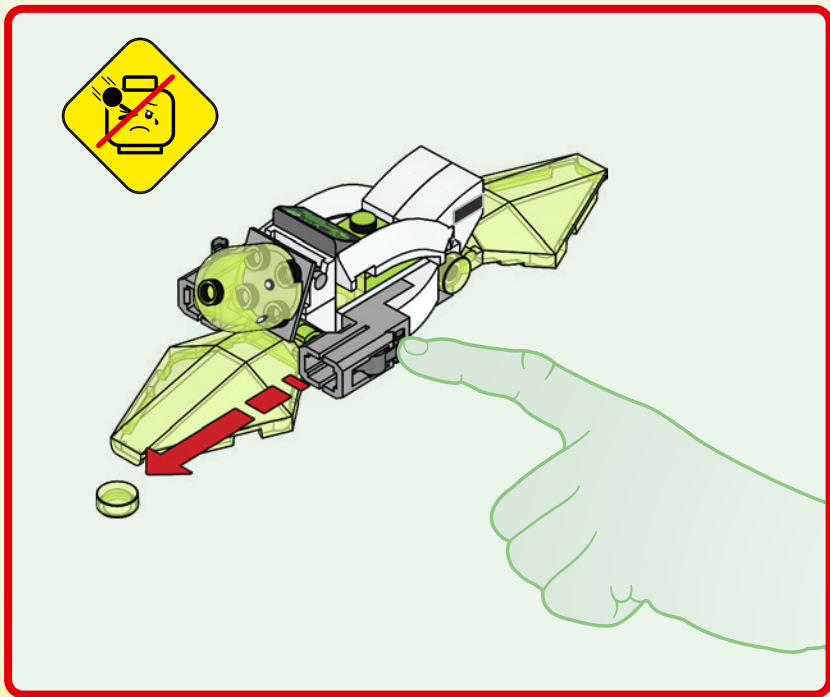





DREAMZZZ



71453



71454



71455



71459



71460



71456



71457



71458



71461



71469



REGARDEZ
LA SÉRIE
EN LIGNE

MIRA
LA SÉRIE
EN INTERNET



DREAMZZZ

WATCH
SERIES
ONLINE 



 LEGO.com/DREAMzzz



Rebuild
the
world™





1x
6443399



1x
6284587



1x
6434196



1x
6444464



2x
6284070



2x
4548180



2x
300326



2x
6039194



1x
4162916



4x
6437507



2x
6347293



1x
6434207



2x
4286267



1x
6195325



4x
6432442



4x
6105963



2x
4206482



4x
6328192



2x
6430887



1x
6434220



4x
4558954



2x
6280097



4x
6305216



1x
6172984



1x
4529237



4x
6177349



2x
6051511



1x
6434200



3x
6335388



3x
302326



2x
4604304



3x
366626



1x
6434257



4x
4519195



4x
6034044



1x
6135186



2x
6335317



1x
4225201



1x
6338171



4x
379526



3x
6135494



6x
6103415



4x
6372037



1x
379501



4x
6209519



4x
4213374



3x
6360825



1x
244526



1x
6134252



2x
6207783



1x
6434219



1x
6131572



1x
6444495



3x
6053077



1x
4560182



12x
302226



1x
6376752

102

3

2x
6227897

2x
6313114

2x
4654582

2x
6326478

1x
4211881

2x
6360382

1x
4211395

1x
4211406

10x
6343976

6x
6168647

1x
4211483

1x
6251308

2x
6248078

1x
4210700

2x
6360675

4x
6221607

4x
6296892

4x
6439040

6x
6199549

1x
6194290

1x
6434202

3x
6395363

2x
6336990

2x
6302647

4x
6398662

2x
6178919

8x
6029948

2x
6215212

4x
6308045

1x
6350292

1x
4211043

1x
6214214

6x
6276869

1x
6037634

2x
6423977

2x
6167034

6x
6274748

1x
6434203

1x
6244911

2x
6423004

1x
6443372

4x
6347285

1x
4537937

1x
6440804

6x
6275487

10x
6267417

 [LEGO.com/service](https://www.LEGO.com/service)



YOU COULD **WIN**



Scan this QR code or go to **LEGO.COM/PRODUCTFEEDBACK** and give us your short feedback about this LEGO® set for a chance to win a cool LEGO prize.

Terms and Conditions apply*

EN: YOU COULD WIN. Terms and Conditions apply* **DE: Du könntest GEWINNEN.** Es gelten die Teilnahmebedingungen* **FR: Tu pourrais GAGNER.** Des conditions s'appliquent* **IT: Potresti VINCERE tu.** Termini e condizioni sono applicabili* **ES: Puedes GANAR.** Aplican términos y condiciones* **PT: Poderá GANHAR.** Aplicam-se termos e condições* **ZH: 轻松获奖. 条款和条件适用*** **PL: Szansa na WYGRANĄ.** Obowiązują warunki korzystania* **CS: Máte šanci VYHRÁT.** Platí všeobecné smluvní podmínky* **SK: Máte šancu VYHRÁŤ.** Platia všeobecné zmluvné podmienky* **HU: TE IS NYERHETSZ.** Felhasználási feltételek érvényesek* **RO: Ai putea CÂȘTIGA.** Se aplică termenii și condiții* **BG: Можете да СПЕЧЕЛИТЕ.** Има определени правила и условия* **LV: Tu vari LAIMĒT.** Ir spēkā noteikumi un nosacījumi.* **ET: Sul on võimalus VÕITA.** Kehtivad tingimused* **LT: Jūs galite LAIMĖTI.** Taikomos sąlygos*

*[LEGO.com/productfeedback-terms](https://www.lego.com/productfeedback-terms)

LEGO, the LEGO logo, DREAMZzz and the DREAMZzz logo are trademarks of the/son des marques de commerce du/son marcas registradas de LEGO Group.
©2023 The LEGO Group. All rights reserved/Tous droits réservés/Todos los derechos reservados. 6474149